



Originalanleitung
Original instructions
Notice originale
Manual original

Oryginalna instrukcja
Оригинальная инструкция
Instrução original
Originalanvisning

D+H

DXD-BS037-OM

Für: / For: / Pour: / Por: / Dla: / Для: / Para: / For:
Raico® WING 105-DI

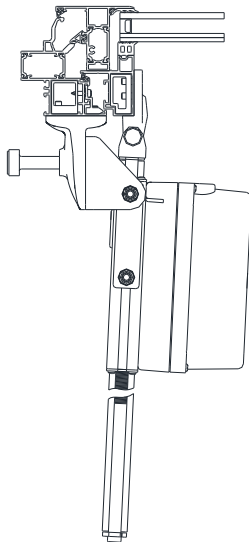

Raico® WING 105-DI

Vor Montagebeginn bitte unbedingt die profilspezifischen Montagehinweise gemäß D+H Anwendungszeichnung beachten.

Before mounting, the profile specific mounting instructions in the D+H application drawings must be taken into account.

Avant l' installation, prière de respecter les instructions de montage spécifiques du profil selon les dessins techniques d'utilisation de D+H.

Antes de montar se deben tener en cuenta las instrucciones de montaje específicas del perfil en los dibujos de aplicaciones de D+H.

Przed przystąpieniem do montażu na określonym, konkretnym profilu należy zapoznać się z instrukcją montażu i dokumentacją techniczną D+H.

Перед монтажом необходимо принимать во внимание инструкции по установке для данного профиля согласно чертежам D+H.

Antes do início da montagem, por favor respeitar imperativamente as instruções de montagem específicas dos perfis conforme o desenho de utilização da D+H.

Før montagestart bemærk da venligst de profilspecifikke montageanvisninger i.h.t.D+H's anvendelsestegninger.

Pravo do zmian technicznych zastrzeżone.
Права на технические изменения сохраняются.
Modificacoes técnicas reservadas.
Forbehold for tekniske ændringer.

Technische Änderungen vorbehalten.
Rights to technical modifications reserved.
Tout changement technique réservé.
Se reserva el derecho a realizar modificaciones técnicas

11x M6x16 DIN-7984



2x M6x20 DIN-6912



2x 3,9x16 DIN-7504



2x M8x20 DIN-603



2x M8x25 DIN-603

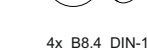

4x B8.4 DIN-125



4x M8 DIN-985



2x



2x

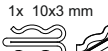

1x 10x3 mm



1x 10x55 mm

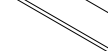

2x



2x 70.900.13

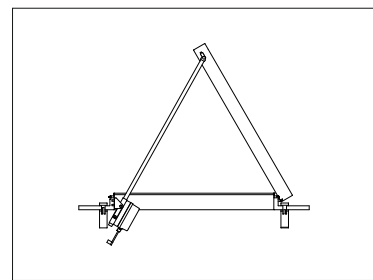
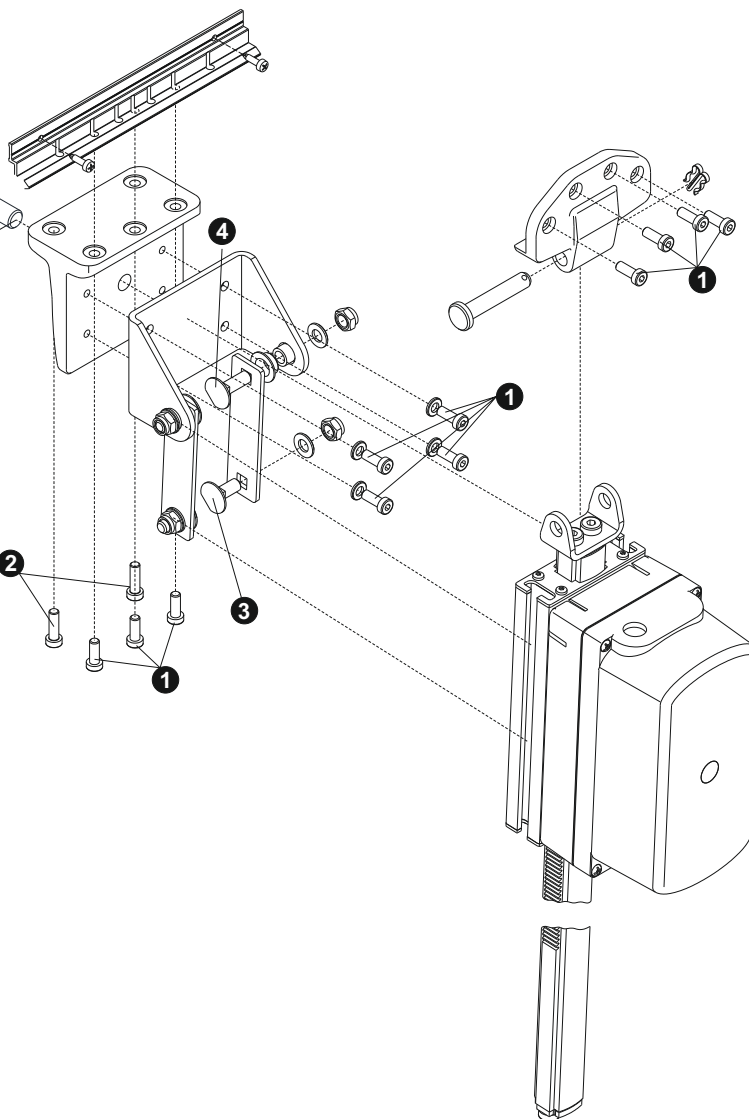
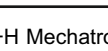

Für gegenüberliegende Montage
For opposite mounting
Pour le montage en face
Para fijación opuesto
Dla montażu naprzeciw
для противоположного монтажа
Para instalação em face
For montage modsat hængselsside

99.882.40 1.1/02/16
© 2014 D+H Mechatronic AG, Ammersbek