

CDC-0252-0500-5-ACB M1-R



Performance features

- + Can be used for openings for smoke exhaust; D+H Euro SHEV in accordance with EN 12101-2; and for daily ventilation
- + With BSY+ motor and synchronised electronics controlled via microprocessor
- + Perfectly suited for profile integrated and surface mounted installation
- + Low running noises thanks to the innovative acoustic decoupling of the drive components
- + Direct control via 230 V AC
- + Universal bracket sets for installation of all commonly available profile systems
- + Flexible overall lengths for customised strokes
- + Available in all RAL colours
- + Integrated ACB (Advanced Communication Bus) bus interface with Modbus RTU protocol
- + The drive is integrated directly via open bus communication through the ACB (Advanced Communication Bus), e.g. in a building management system

Approvals / Certificates

Find out about permission details from your D+H Partner.



Technical data

CDC-0252-0500-5-ACB M1-R

Supply	230 V AC / +10 % ... -15 % / 50 Hz
Performance	33 W / 45 VA
Duty cycle	30 % (ON: 3 min. / OFF: 7 min.)
Force of pressure	250 N
Tensile force	250 N
Nominal locking force **	1500 N
Service life	20000 double strokes *
Stroke	500 mm
OPEN running speed	6.7 mm/s
OPEN running speed - SHEV	13.6 mm/s
CLOSED running speed	6.7 mm/s
Type of protection	IP 32
Emission sound pressure level	LpA ≤ 35 dB(A)
Temperature range	-15 °C (-5 °C ***) ... +75 °C
Fire resistance	B300 (30 min / 300 °C)
Housing	Aluminium
Surface	Powder-coated
Colour	White aluminium (~ RAL 9006)
Connection	2.5 m silicone cable
W x H x D	625 x 30 x 39 mm
Weight	1.4 kg
Remark	Right type
Art. No.	26.105.55

* For vertical use, please consult with D+H Sales!

** Depending on the mounting, *** in accordance with VdS 2580

Dimensions

All specifications in mm

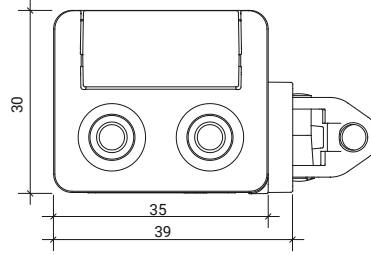
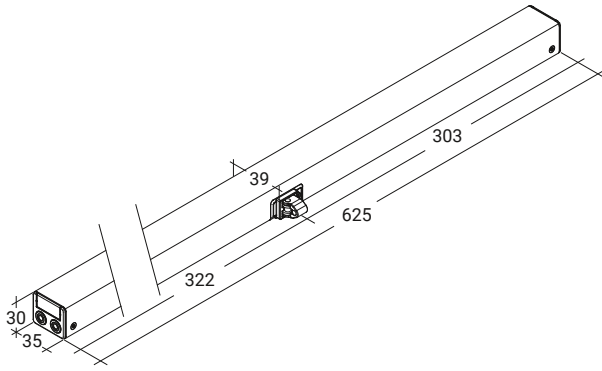

Pressure load diagram

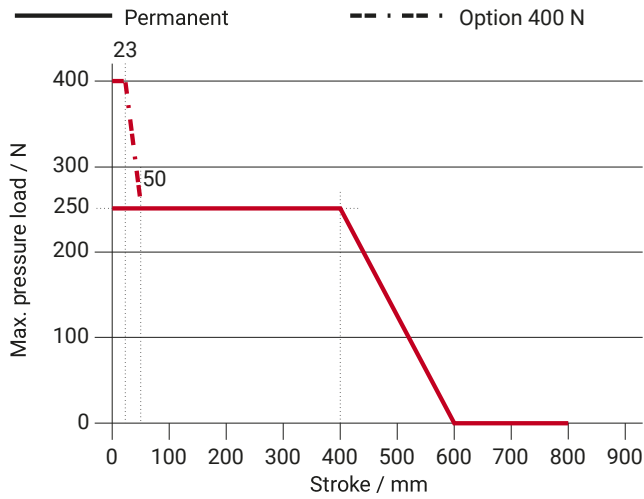

Possible applications

- + Mounted installation
- + Application tension
- + Integrated installation
- + Trapezoidal application
- + Frame mounting
- + Drawbridge application
- + Sash mounting
- + Application force

