

CDM-1000-0800-1-ACB M2

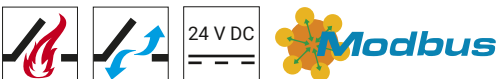

Performance features

- + Can be used for openings for smoke ventilation; D+H Euro SHEV in accordance with EN 12101-2; and for daily natural ventilation
- + With BSY+ motor and synchronised electronics controlled via microprocessor
- + Option of up to 4 drives in one synchronous group
- + High-speed function (HS) for especially fast opening windows in case of fire (SHEV)
- + Low running noises thanks to the innovative acoustic decoupling of the drive components
- + Special chain stabilisation and centred chain outlet
- + Compact design thanks to triple deflection of the chain
- + Use of a highly efficient, wear-free brushless motor
- + Relief of pressure on window gasket after closing process
- + Programmable drive functions and different drive parameters
- + Time-controlled reversing when an obstacle is detected in the CLOSED direction (active closing edge protection)
- + Integrated ACB (Advanced Communication Bus) bus interface with Modbus RTU protocol
- + The drive is integrated directly via open bus communication through the ACB (Advanced Communication Bus), e.g. in a building management system

Approvals / Certificates

Find out about permission details from your D+H Partner.



Technical data

CDM-1000-0800-1-ACB M2

Supply	24 V DC / $\pm 15\%$ / 2.5 A
Duty cycle	30 % (ON: 3 min. / OFF: 7 min.)
Force of pressure	1000 N
Tensile force	1000 N
Nominal locking force	3500 N
Service life	> 20000 double strokes
Stroke	800 mm
OPEN running speed	7 mm/s
OPEN running speed - SHEV	15 mm/s
CLOSED running speed	5 mm/s
Type of protection	IP 42
Emission sound pressure level	LpA \leq 45 dB(A)
Temperature range	-15 °C ... +75 °C
Fire resistance	B300 (30 min / 300 °C)
Housing	Aluminium
Surface	Powder-coated
Colour	White aluminium (~ RAL 9006)
Connection	Silicone cable (must be ordered separately)
Dimension A	671 mm
Dimension B	398 mm
W x H x D	671 x 53 x 90 mm
Weight	5.5 kg
Art. No.	26.200.22

Dimensions

All specifications in mm

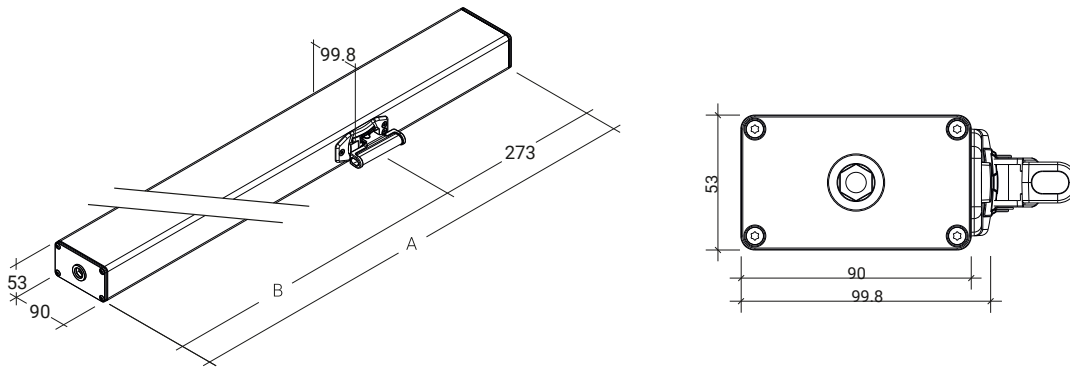

Pressure load diagram

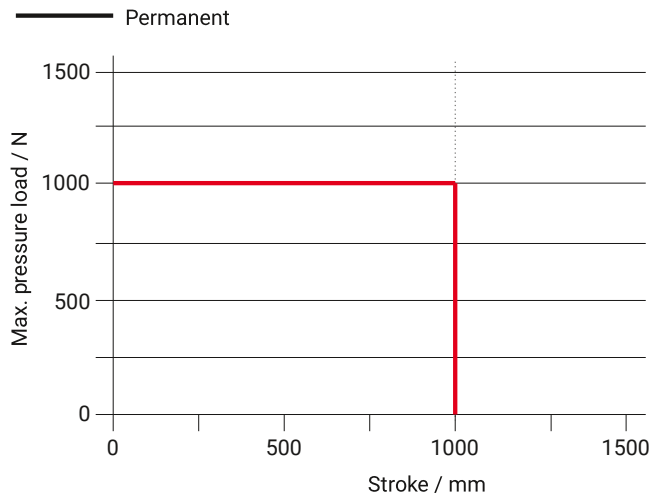

Possible applications

- + Mounted installation
- + Application force
- + Frame mounting
- + Application tension

