

# ZA-0300-0350-1-PLP-R

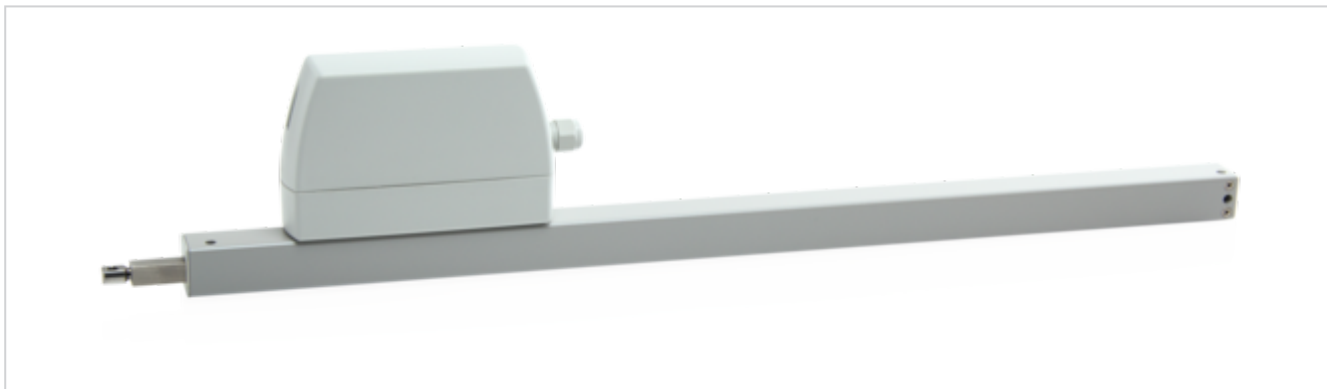

## Performance features

- + Can be used for openings for smoke ventilation; D+H Euro SHEV in accordance with EN 12101-2; and for daily natural ventilation
- + With motor electronics controlled via microprocessor
- + High-speed function (HS) for especially fast opening windows in case of fire (SHEV) (optionally available)
- + Low current consumption thanks to high efficiency
- + Option of cable infeed above and below
- + Drive unit can be changed from left to right
- + Programmable drive functions and different drive parameters
- + Running speed in CLOSED direction decreases to 5 mm/s (passive closing edge protection)
- + Time-controlled reversing when an obstacle is detected in the CLOSED direction (active closing edge protection)

## Approvals / Certificates

Find out about permission details from your D+H Partner.



Article also available with the following permissions under other article numbers. Technical data may deviate.



# Technical data

ZA-0300-0350-1-PLP-R

<b>Supply</b>	24 V DC / $\pm 15\%$ / 0.5 A
<b>Duty cycle</b>	30 % (ON: 3 min. / OFF: 7 min.)
<b>Force of pressure</b>	300 N
<b>Tensile force</b>	300 N
<b>Nominal locking force **</b>	Max. 1400 N (1100 N ***)
<b>Service life</b>	20000 double strokes *
<b>Stroke</b>	350 mm
<b>OPEN running speed</b>	7.1 mm/s
<b>OPEN running speed - SHEV</b>	8 mm/s
<b>CLOSED running speed</b>	7.1 mm/s
<b>Type of protection</b>	IP 65
<b>Emission sound pressure level</b>	LpA $\leq$ 51 dB(A)
<b>Temperature range</b>	-15 °C (-5 °C ***) ... +75 °C
<b>Fire resistance</b>	B300 (30 min / 300 °C)
<b>Housing</b>	Aluminium / Polycarbonate
<b>Surface</b>	Powder-coated
<b>Colour</b>	White aluminium (~ RAL 9006)
<b>Connection</b>	2.5 m silicone cable
<b>Dimension A</b>	512 mm
<b>Weight</b>	1.72 kg
<b>Art. No.</b>	27.005.05

\* For vertical use, please consult with D+H Sales!

\*\* Depending on the mounting, \*\*\* in accordance with VdS 2580

# Dimensions

All specifications in mm

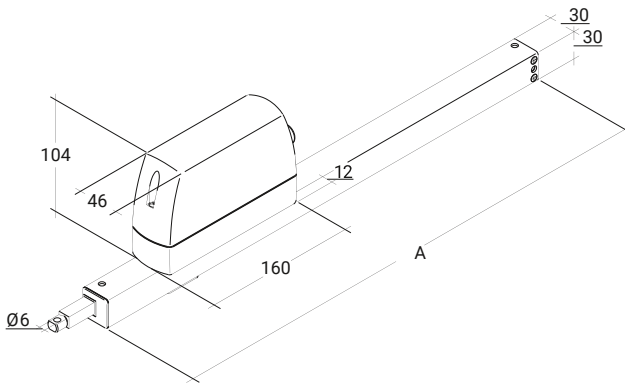

# Pressure load diagram

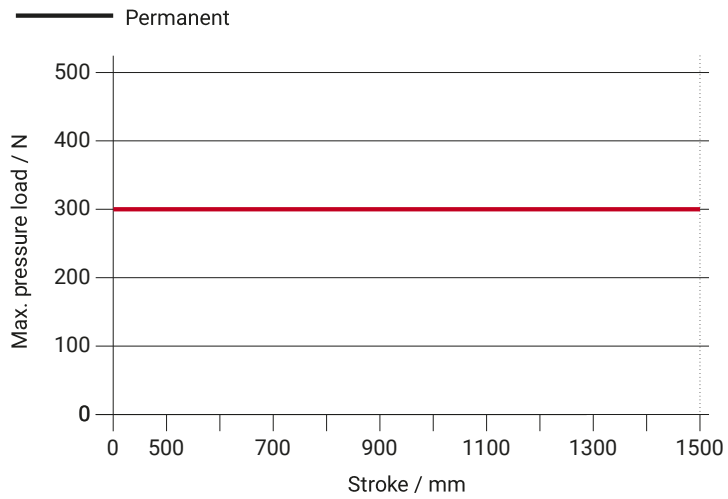

# Possible applications

- + Mounted installation
- + Side installation
- + Frame mounting
- + Application force
- + Sash mounting
- + Application tension
- + Installation opposite the hinge

